

CM-4000 Conference System

CLEAR Conferencing in...
Conference Rooms...
Seminar Halls...
Convention Centres...



CM-4000

Conference System

- *Easy to Install*
- *Easy to Use*
- *Effective Performance*
- *Expandable & Versatile*
- *Extremely Rugged*
- *Exceedingly Reliable*
- *Economical Installation*



Effective communication for upto 100 Delegates

The Ahuja CM-4000 Conference System provides the much required sound reinforcement at meetings while eliminating problems of poor intelligibility and acoustic feedback. The system is ideal for use in a variety of applications in Boardrooms, Large Conference Halls as well as open conferencing in Convention Centres.

The **CMC-4100 Chairman** and **CMD-4200 Delegate Units** have built-in loudspeakers and high quality sensitive electret condenser transducer mounted on 16" flexible goosenecks. The microphones of the units are equipped with a Ring LED indicator for

easy visual identification of the Delegate Unit in operation. Each unit has a headphone output with volume control.

The stylish, free-standing cast aluminium case has an angled facia incorporating the TALK switch which automatically mutes the internal speaker.

The Chairman Unit also has a non-lockable PRIORITY switch which interrupts the meeting with a chime tone and mutes the delegates' microphones. Both units have recessed volume controls for setting desired sound levels.

The matching **CMS-4300 Secretary Unit** has a built-in loudspeaker and a headphone output with volume control. The Secretary Unit enables proceedings to be recorded through a cassette recorder, for a stenographer present to take notes and to relay pre-recorded messages or music to delegates.



CMC-4100
Chairman Unit



CMD-4200
Delegate Unit



CMS-4300
Secretary Unit

CMA-4400



Central Amplifier

At the core of the conference system is the **Central Amplifier CMA-4400** which has a built-in **50W PA Amplifier** with inputs for three microphones and an auxiliary source.

The PA SECTION of the Central Amplifier has Bass, Treble, Master volume controls and a output level LED array. Low impedance and 70V/100V outputs have been provided for connecting external speakers.

The CONFERENCE SECTION has a separate Line Level control for adjusting the overall signal level of the Chairman and Delegate units.

The Central Amplifier is housed in a robust metal case and is powered from AC mains with automatic change-over facility to 24V DC battery as an standby power source.

Basic System Configuration

Chairman Unit	
CMC-4100	1 Unit
Delegate Unit	
CMD-4200	N Units (upto 50 nos. as per requirement)
Secretary Unit	
CMS-4300	1 Unit
Central Amplifier	
CMA-4400	1 Unit

FEATURES

- The Chairman, Delegate and Secretary Units are housed in compact & attractive die cast aluminium cabinet with a unique profile.
- 16" slim and flexible goosneck microphone with bright ring LED indicator. Highly sensitive electret condenser microphone for comfortable sharing by two delegates.
- Since these microphones are often used close to the mouth, each microphone is supplied with a foam windshield which helps in reducing breath noise and pop noise.
- Automatic Mic Off function in Delegate Units. Delegate unit microphone can be set to automatically turn off after approx. 75 seconds if a delegate forgets to turn it off after use.
- Clear and intelligible sound is reproduced by the speaker of each unit.
- Headphone output with volume control is available in each unit.
- Upto 50 Delegate units can be quickly connected through fully detachable leads.
- One touch switch for mic activation with TALK LED indicator in Chairman and Delegate units.
- Priority function in Chairman Unit mutes all active delegate microphones and preceded by a chime tone.
- Secretary Unit provides facility for recording proceedings and playback of music, messages etc.
- Central Amplifier operates on 220-240V AC mains and 24V car battery.
- The Central Amplifier can deliver 50W RMS output to drive external reinforcement speakers.
- One balanced and 2 unbalanced Mic inputs with one Aux input provided for various user applications like connecting wireless roving Mic, Podium Mic, A/V audio out etc.
- Send/Return facility provided in Central Amplifier for connecting external signal processors like feedback destroyer, compressor limiter, graphic equalizer etc.
- All the units can be connected in a bus bar arrangement with the help of CB-45 junction box.
- System expansion beyond 50 units possible with the help of Conference Expansion Unit CMB-4500.



CM-4000 meets European Union regulations and complies with EMC and LVD standards as applicable.

SYSTEM EXPANSION

The Central Amplifier CMA-4400 is designed to control up to 50 conference units. Since each delegate unit can be shared by two delegates, the system enables the participation of 100 delegates. However in large installations, the number of conference units may exceed the controlling capacity of a single Central Amplifier CMA-4400. Therefore the capacity can be enhanced by expanding the system through Conference Expansion Unit CMB-4500.

For example, if 70 Delegate Units are required, then two groups of 35 units each should be formed using one no. CMA-4400 and one no. CMB-4500. However, depending upon cable length and other factors, additional numbers of Expansion Unit CMB-4500 may be required.

One such example is described below where the total number of conference units is equally divided in two groups namely G1 & G2. The conference units of each group must be connected in a closed loop.

The closed loop of group G1 is obtained by connecting its units between the two LINE connectors of the Central Amplifier CMA-4400 and the two LINE connectors A1 & A2 of the Conference Expansion Unit CMB-4500.

Finally, the units of group G2 are connected in a closed loop by using the two LINE connectors B1 & B2 of the Conference Expansion Unit CMB-4500.

The overall level of the system is adjusted by the LINE level control of the Central Amplifier CMA-4400.

If required, the sound reinforcement level should be enhanced by connecting external speakers to the Central Amplifier CMA-4400.

Each Central Amplifier and Conference Expansion Unit is supplied with 10m each of Connection Cable CC-46 and Extension Cable CC-47. Both connection and extension cables are also available in different lengths of 5m, 10m and 20m as optional accessories.

Installations with long cable length may require additional power supply and ground connections. Special injection boxes and cables for this can be provided on request.

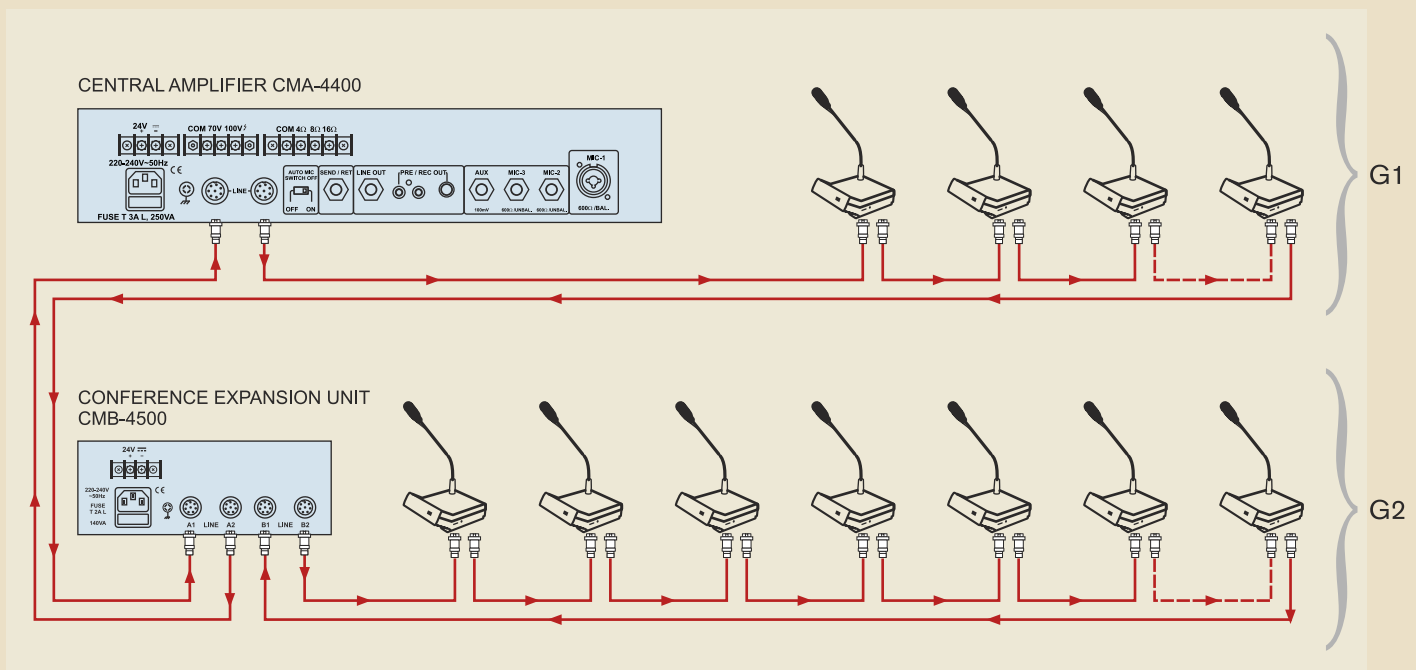

CMB-4500

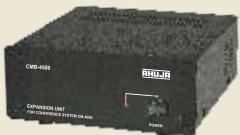

Conference Expansion Unit

A passive unit for adding more units to the system. This unit also provides interconnection with the Central Amplifier CMA-4400. Works on 220-240V AC mains as well as 24V car battery.

CC-46



Connection Cable

10m connection cable terminated with 8-pin female plugs on both ends.

CC-47



Extension Cable

10m extension cable terminated with 8-pin female plug at one end and 8-pin male plug at the other end.

CB-45



Junction Box

Suitable for connecting the conference units in a bus bar arrangement.

TYPICAL APPLICATIONS

CONFERENCE HALL

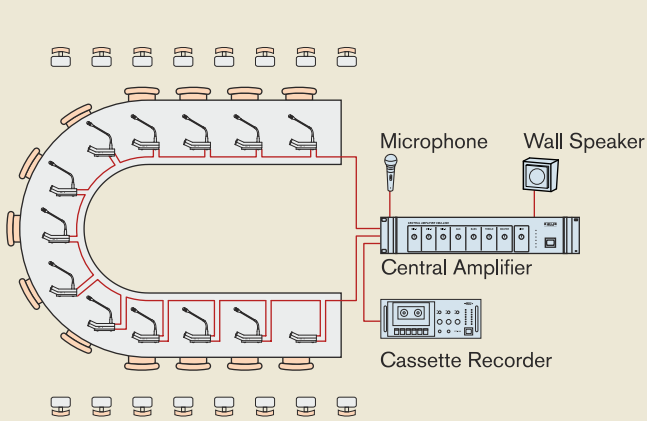

AUDITORIA

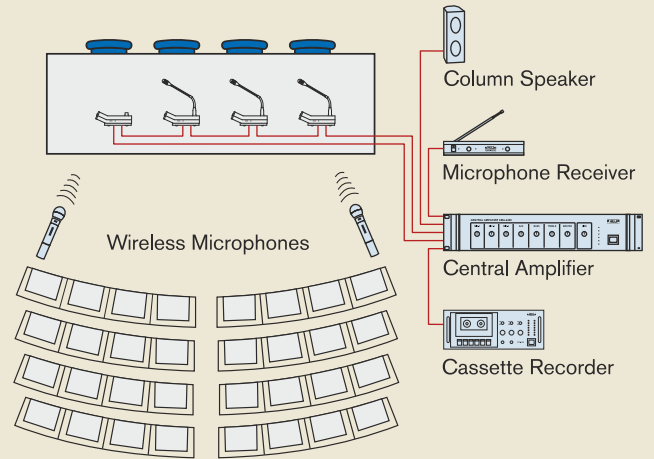

BOARDROOMS

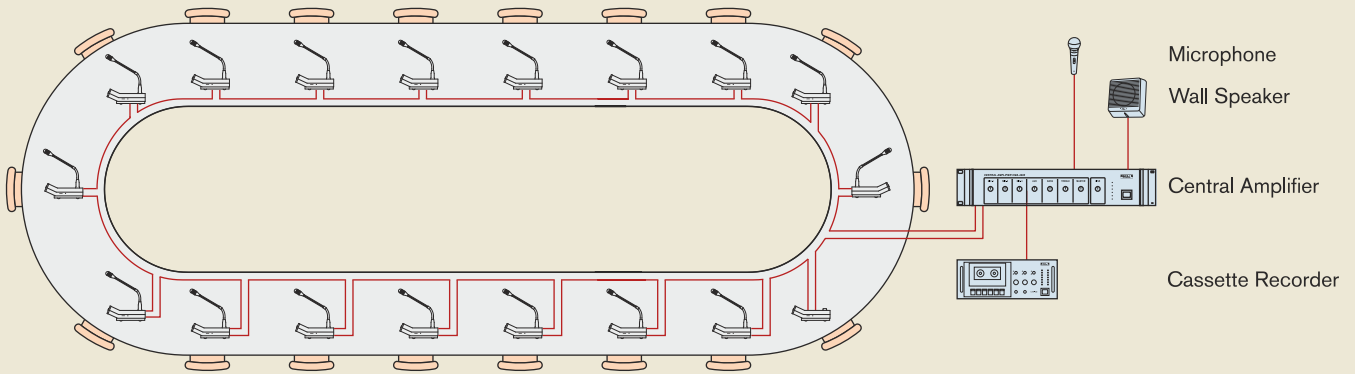

CONVENTION CENTRES

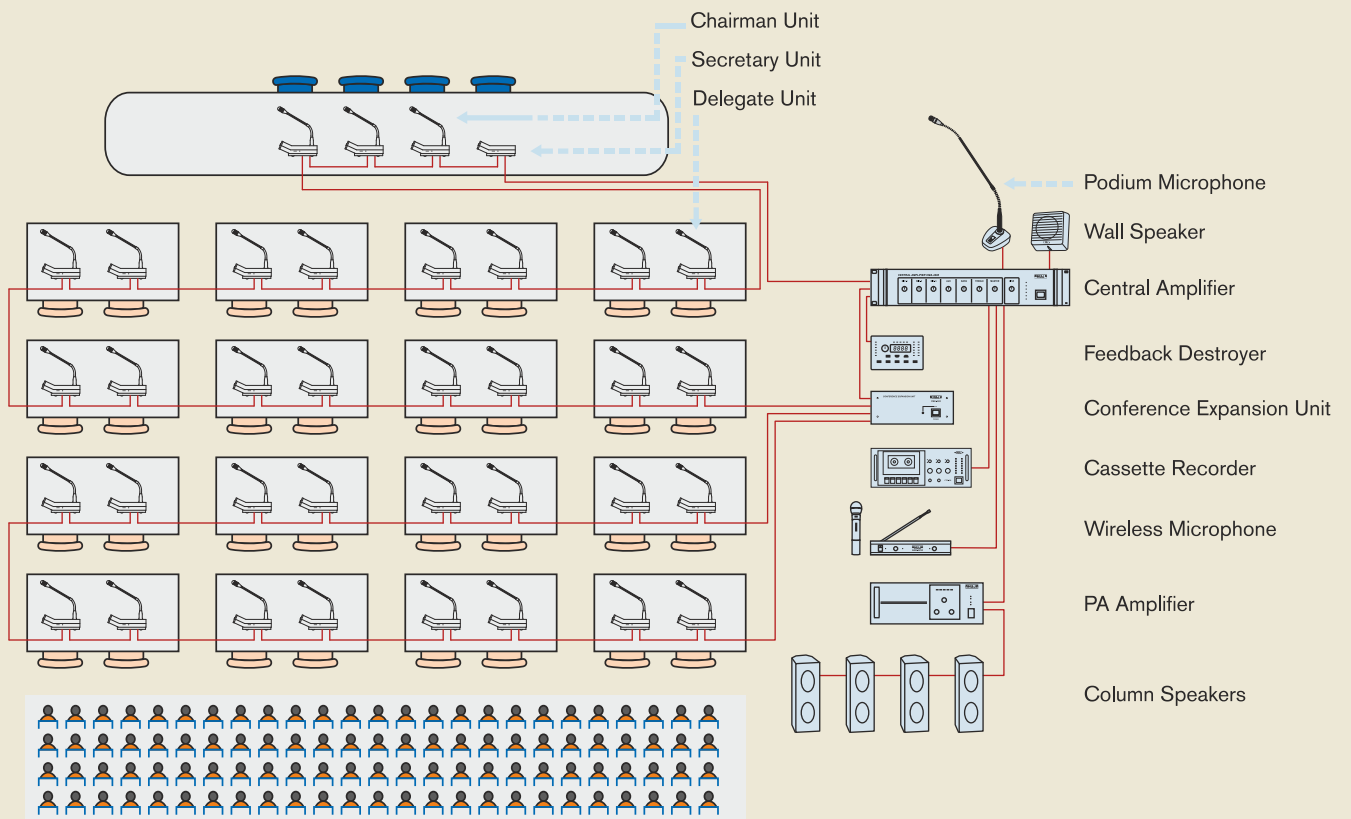

SPECIAL FUNCTIONS

- ✓ Compact, Attractive & Stable housing.
- ✓ 16" Slim Flexible Gooseneck Microphone with ring LED indication.
- ✓ Chairman's Priority Switch provided.
- ✓ Headphone facility in each unit with Volume Control.
- ✓ Auto Mic-off function.
- ✓ 50W built-in PA Amplifier.
- ✓ AC/24V DC Operation.

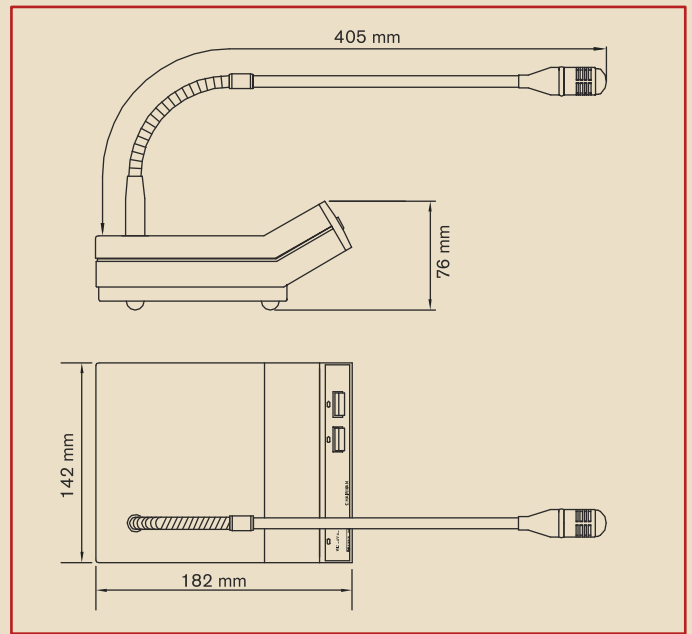

SPECIFICATIONS

CMA-4400

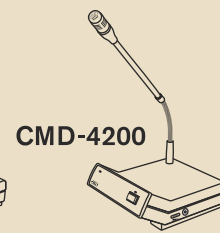
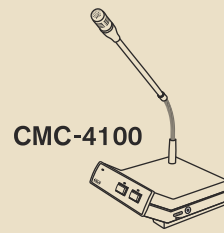
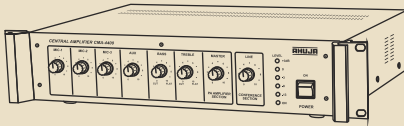

Line Output	17.5V DC/3A Max.; -34dBV (20mV)
Power Output	50W RMS at 2% THD 90W Max.
Inputs	1×Mic 1.0mV/2kΩ (Balanced) 2×Mic 0.65mV/4.7kΩ (Unbalanced) 1×Aux 100mV/470kΩ (Unbalanced)
Frequency Response	60-14,000Hz (± 3dB)
S/N Ratio	> 60dB
Tone Controls	Bass : -10dB at 100Hz Treble: -10dB at 10kHz
Preamp / Rec Output	200mV/600Ω
Line Output	1V/1kΩ
Send Output	200mV/600Ω
Return Input	200mV/10kΩ
Speaker Output	4Ω, 8Ω, 16Ω, 70V & 100V
Power Requirement	AC: 220-240V, 50/60HZ DC: 24V Car Battery
Power Consumption	250VA
Protections	AC Fuse 1×3 Amp DC Fuse 2×10 Amp
Dimensions	W482 × H88 × D295 mm
Weight	8.70kg
Accessories	1× Connection Cable CC-46 1× Extension Cable CC-47 1× Fuse 3 Amp, 1 × Fuse 10 Amp.

	CMC-4100	CMD-4200	CMS-4300
Microphone	-63dBV/μbar 7.5mV/Pa	-63dBV/μbar 7.5mV/Pa	- -
Current Consumption	< 50mA Max.	< 50mA Max.	< 50mA Max.
Mic Auto Switch-Off Time	75 seconds approx.	75 seconds approx.	-
Input	Line	Line	Line, Playback
Output	Line, Headphone with Volume Control	Line, Headphone with Volume Control	Line, Record, Headphone with Volume Control
Speaker	Max Input 300mW Impedance 16Ω	Max Input 300mW Impedance 16Ω	Max Input 300mW Impedance 16Ω
Controls	Priority Switch, Talk Switch, Speaker Volume Control, Headphone Volume Control	Talk Switch, Speaker Volume Control, Headphone Volume Control	Monitor Speaker Volume Control, Headphone Volume Control
Dimensions (Base) in mm	W145×H75×D180	W145×H75×D180	W145×H75×D180
Weight	1.30kg (w/o cable)	1.30kg (w/o cable)	1.15kg (w/o cable)
Accessories	Foam Windshield, 2.5m Interconnecting Cable	Foam Windshield, 2.5m Interconnecting Cable	4 Pin Plug for REC/PB, 2.5m Interconnecting Cable

For further details, please contact:

Design and Specifications are subject to change without notice owing to continuous product up-gradation.

Technical specifications are subject to production tolerances.

AHUJA is a registered trademark of Ahuja Radios in India and other countries.

© Copyright Ahuja Radios, 2005. All rights reserved. Any unauthorized reproduction or use of logos, images or design elements is strictly prohibited by law. No part of the compilation may be reproduced in any manner or translated without written permission.

AHUJA RADIOS

215, Okhla Industrial Estate, New Delhi-110 020, India

Tel: +91-11-26831549/51612475 Fax: +91-11-26847287/51616563

Email: ahuja@ahujaradios.com admin@ahujaradios.com www.ahujaradios.com