

**AHUJA**®

**8 CHANNEL  
PA MIXER  
with Digital Effects**

OPERATION MANUAL

# FMX-108DP

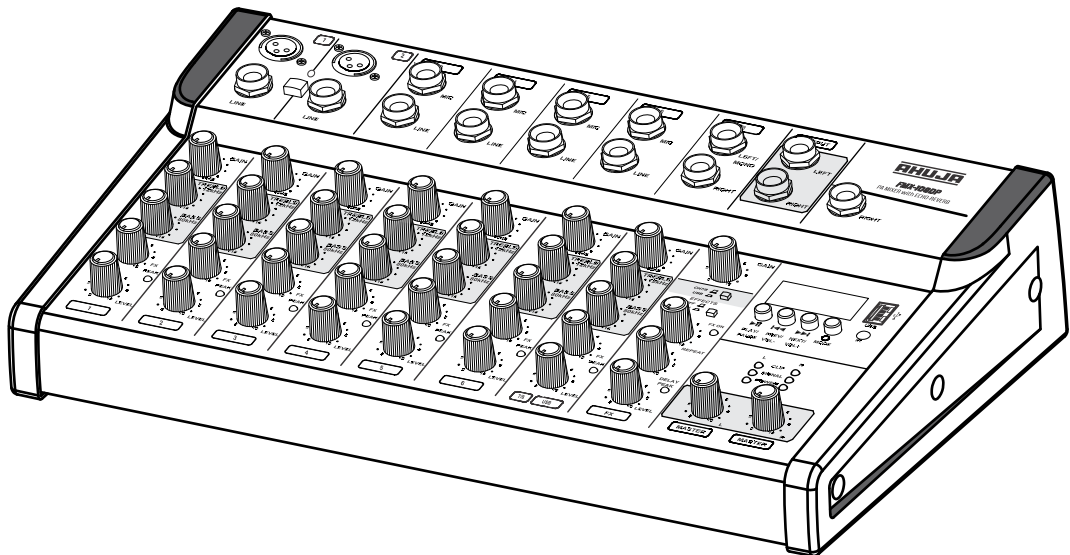

- 
- ◆ Thank you for purchasing the AHUJA PA Mixer.
  - ◆ Please read this manual thoroughly before making connections and turning on the power. Following the instructions in this manual will enable you to obtain optimum performance from your new AHUJA PA Mixer.
  - ◆ Please retain this manual for future reference.

## • Safety Instructions

**Read the Instructions:** Please read all the instructions in this section carefully before installation or use of the product. All the safety instructions must be followed.

**Retain the Instructions:** Please retain this Instruction Manual for future reference.



This symbol, wherever it appears, alerts you to the presence of uninsulated hazardous voltage that may be sufficient to constitute a risk of electric shock. External wiring to any terminal marked with this symbol must be done by a trained and instructed person only.



This symbol, wherever it appears adjacent to a component, alerts you that the concerned component can only be replaced by another of the exact same specifications.

### **WARNING**

To reduce the risk of electric shock, do not remove the top plate. No user serviceable parts inside. Refer all servicing to qualified personnel only.

### **CAUTIONS**

**Water & Moisture:** To reduce the risk of fire or electrical shock, do not expose this set to rain or moisture. Do not use this set near water or in a wet location. Do not keep any object filled with liquid, such as a vase, on top of this set. Do not insert or remove the AC mains plug with wet hands.

**Power Source:** The voltage & frequency of the AC mains supply, and the voltage of the external battery, (if applicable) to which this set can be connected, is marked on the rear panel of the set. Do not connect this set to any power source other than those specified on the rear panel.

**Power Cord Protection:** Do not cut, kink, damage or modify the AC power cord supplied with this set. Keep the AC power cord away from heaters and harmful chemicals. Do not keep any heavy object on the power cord.

**Operation on Generator:** When operating this set on a generator, make sure the set is switched off till the generator voltage has stabilized.

**Stability:** This set must be kept in a stable and flat horizontal position, and never in a tilted position. Do not place this set on an unstable stand, tripod, bracket or mount. Do not use attachments which are not supplied or explicitly recommended by the manufacturer.

**Earthing:** This set must be earthed properly before use. A wire from the Earth terminal on the rear panel must be connected to electrical earth.

**Cleaning:** Disconnect this equipment from the AC mains before cleaning. Clean with a damp cloth, but do not allow any liquid to enter the set. Do not clean with liquids or aerosols.

## • Table of Contents

<b>Contents</b>	<b>Page No.</b>
• <b>Features / General Description of Product</b> .....	<b>3</b>
• <b>Input Channel Controls and Functions</b> .....	<b>4</b>
• <b>The Power Supply Section</b> .....	<b>4</b>
• <b>Stereo Channel Controls &amp; Functions</b> .....	<b>5</b>
• <b>Main Outputs, Phones &amp; Effects Controls &amp; Functions</b> .....	<b>5</b>
• <b>MP3 Record &amp; Playback Controls &amp; Functions</b> .....	<b>6</b>
• <b>Output LEDs &amp; Master Controls &amp; Functions</b> .....	<b>6</b>
• <b>Remote Control</b> .....	<b>7</b>
• <b>Pairing of Bluetooth Device</b> .....	<b>7</b>
• <b>Plugs Wiring</b> .....	<b>7</b>
• <b>Interconnections</b> .....	<b>8</b>
• <b>Specifications</b> .....	<b>8</b>

## • Features / General Description of Product

- Compact and reliable professional PA Mixer which is aesthetically superior and easily portable.
- Provided with two balanced XLR microphone inputs, with switchable +48V Phantom supply.
- Additionally, four low impedance microphones can be connected in either balanced or unbalanced configuration, through a 6.3 mm (1/4") stereo jack socket.
- Upto six line level signal sources can be connected in either balanced or unbalanced configuration, through a 6.3mm (1/4") stereo jack socket.
- Each channel has a GAIN control for optimum adjustment of the MIC & LINE input sensitivities.
- Two band equalizer with active BASS & TREBLE controls in each channel for desired equalisation of the input signal.
- Separate FX (effects) level control for each input channel.
- MP3 digital player with recording and playback through USB. Bluetooth facility also available.
- One independent stereo input channel is provided with a GAIN control, 2 band EQ, FX & LEVEL Controls.
- Each channel has a PEAK LED which glows when the level of input signal is excessive.
- A push switch is provided for selection between Ch 7/8 and USB channel.
- Built-in digital effects processor with DELAY, REPEAT and LEVEL controls.
- Effects ON/OFF switch with FX ON & PEAK LEDs.
- Line level LEFT & RIGHT outputs through 6.3 mm (1/4") stereo jack sockets.
- Headphone output, with independent volume control, is available through a 6.3mm (1/4") stereo jack socket.
- Individual SIGNAL & CLIP LEDs for optimum setting of Left & Right output levels.
- Individual MASTER volume controls for Left & Right line outputs.
- Operates on 240V, 50Hz AC Mains.

## • Input Channel Controls and Functions

- MIC INPUT (Ch. 3 to Ch. 6):** This is a 6.3 mm (1/4") stereo jack socket which is suitable for connecting a low impedance microphone in a balanced or unbalanced connection.
- LINE INPUT (Ch. 1 to Ch. 6):** This is a 6.3 mm (1/4") stereo jack socket which is suitable for connecting a balanced or an unbalanced line level input source through a suitable 6.3 mm (1/4") stereo jack plug. The input source can be a guitar, keyboard and other electronic instrument.
- GAIN CONTROL:** For adjusting the optimum gain level of both MIC & LINE input signals. Reduce the GAIN setting when CLIP LED glows continuously.
- TREBLE CONTROL:** For attenuating or boosting the signal level of high frequencies at 12kHz by  $\pm 15$ dB.
- BASS CONTROL:** For attenuating or boosting the signal level of low frequencies at 80Hz by  $\pm 15$ dB.
- FX CONTROL:** For routing the desired level of signal to the built-in digital effects processor,
- PEAK LED:** The red LED glows to indicate that the channel input signal is approaching the saturation (clipping) levels. Occasional blinking of PEAK LED during loud sounds is normally acceptable. If this LED glows continuously, then reduce the input signal level from GAIN control.
- LEVEL CONTROL:** For adjusting the signal level of a channel that is contributed in the overall mix of all the input channels.
- MIC INPUT (Ch. 1 & Ch. 2):** For connecting a low impedance microphone through an XLR socket. These inputs can also be used for connecting phantom powered microphones which require +48V phantom supply.
- PHANTOM LED:** This red LED glows when Phantom switch is in ON position.
- PHANTOM ON/OFF SWITCH:** Keep this switch in ON (pressed) position, if the phantom MIC is connected to Ch. 1 & Ch. 2 Mic inputs.

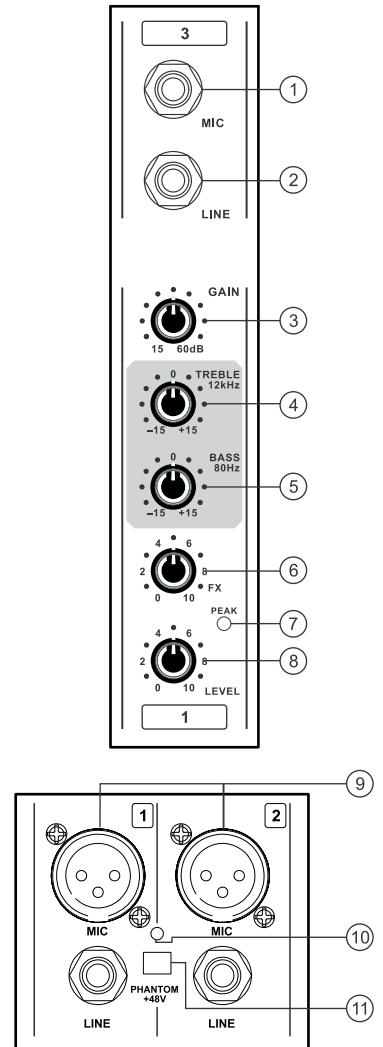

## • The Power Supply Section

- POWER SWITCH:** Push the top part of the knob to switch the mixer ON. Push the bottom part of the knob to switch the mixer OFF.
- AC MAINS FUSE Rating 1Amp 250V (T 1A L):** This protects the mixer from any excessive current flow.
- 2 CORE AC MAINS CABLE WITH PLUG**
- EARTHING SCREW TERMINAL**

### VIEW OF REAR PANEL

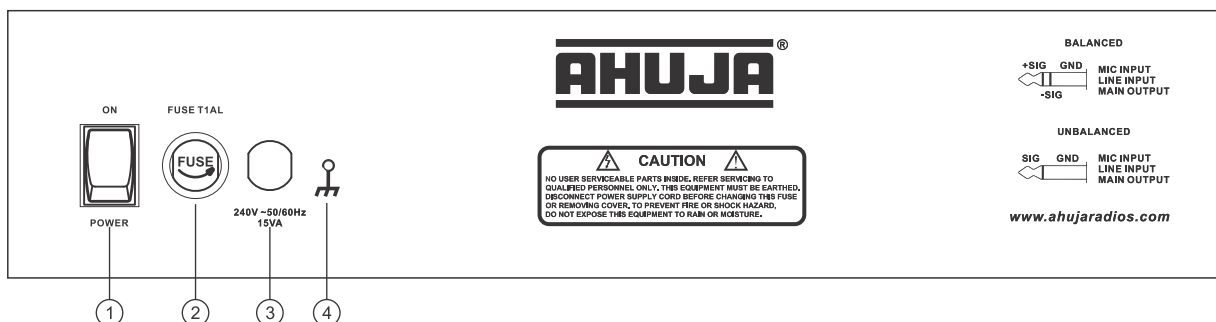

## • Stereo Channel Controls & Functions

- STEREO LINE INPUT:** For accepting balanced LEFT/MONO & RIGHT stereo line level signals through 6.3mm stereo phone jack sockets. However, these inputs can also accept either unbalanced stereo signals, balanced mono signals or unbalanced mono signals. Sources like CD Player, DVD Player, Computer line out etc. can be connected to the stereo input channel.
- GAIN CONTROL:** For adjusting the optimum gain level of signal from both Stereo input & USB player. Reduce the GAIN setting when CLIP LED glows continuously.
- TREBLE CONTROL:** For attenuating or boosting the signal level of high frequencies at 12kHz by  $\pm 15$ dB.
- BASS CONTROL:** For attenuating or boosting the signal level of low frequencies at 80Hz by  $\pm 15$ dB.
- FX CONTROL:** For routing the desired level of signal to the built-in digital effects processor,
- PEAK LED:** The red LED glows to indicate that the channel input signal is approaching the saturation (clipping) levels.  
Occasional blinking of PEAK LED during loud sounds is normally acceptable. If this LED glows continuously, then reduce the input signal level from GAIN control.
- LEVEL CONTROL:** For adjusting the signal level of stereo channel & USB input that is contributed in the overall mix of all the input channels.

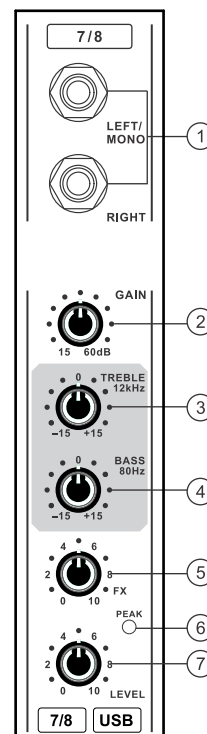

## • Main Outputs, Phones & Effects Controls & Functions

- OUTPUT 'LEFT':** Provides impedance balanced line output of 'LEFT' channel through 6.3 mm (1/4") stereo jack socket. This line level output is suitable for connecting to the line input of a two zone amplifier, booster amplifier etc.
- OUTPUT 'RIGHT':** Provides impedance balanced line output of 'RIGHT' channel through 6.3 mm (1/4") stereo jack socket. This line level output is suitable for connecting to the line input of a two zone amplifier, booster amplifier etc.
- HEADPHONE OUTPUT :** Accepts headphones through 6.3mm(1/4") stereo jack socket.
- HEADPHONE VOLUME CONTROL:** For adjusting the signal level through headphone output.
- SELECTOR SWITCH:** Keep this switch in released position when stereo input channel 7/8 is being used. Keep this switch in pressed position when USB input is being used.
- EFFECTS ON/OFF SWITCH:** For switching effect function ON or OFF during setting up and in live program. Keep the switch in OFF position if digital effects are not to be used.
- FX LED:** The red LED glows to indicate that the built-in effect section is switched ON.
- REPEAT CONTROL:** For setting the number of repetitions within the selected delay time. For example in speech the repeat may be adjusted towards lower position whereas for singing it may be adjusted towards a more higher position
- DELAY CONTROL:** For setting the delay time according to the desired application. For example in speech applications, the delay control may be adjusted towards the lower position. For singing applications, adjust the delay control towards a higher position .
- PEAK LED:** The red LED glows to indicate that the signal to the effects section is approaching the saturation (clipping) levels. Continuous glow of this LED can be controlled by FX control in each channel.
- EFFECTS LEVEL CONTROL:** For setting the level of delay signal in the overall output signal. Nominal position of this control can be near middle position. However, more thrust/impact can be generated in initial repeat signals by setting this control towards higher positions.

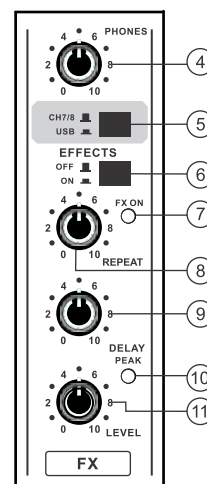
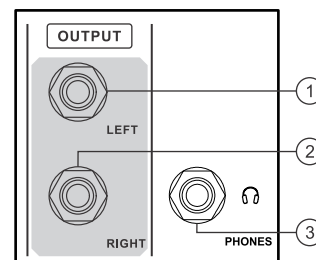

## • MP3 Record & Playback Controls & Functions

- LCD DISPLAY:** When USB device is inserted, the display turns ON & the USB starts to playback. Here the display appears like this:
 
- USB Connector:** Insert the USB drive here. Ensure that the USB drive is inserted in correct direction so as to prevent any damage to the connector.
- IR Sensor:** Picks up signal from the Remote Control.
- MODE BUTTON:** MP3 player has three modes of operation, i.e., USB/REC/BT. These modes can be selected by repeated pressing of Mode button for short duration. If Mode button is repeatedly pressed for longer duration then various preset EQ options can be selected as listed below:  
POP (POP), ROC (ROCK), JAZ (JAZZ), CLA (CLASSIC), CUT (LF CUT), NOR (NORMAL)
- ▶▶ NEXT/VOL+:** For selecting the next track of USB, press this button for short duration. For increasing the output level of MP3 player, press this button for longer duration.
- ◀◀ PREV/VOL-:** For selecting the previous track of USB, press this button for short duration. For decreasing the output level of MP3 player, press this button for longer duration.
- ▶|| PLAY/PAUSE:** Press PLAY/PAUSE once to Pause if music is already playing. Press PLAY/PAUSE again to resume playing. By pressing this button for longer duration, various options of REPEAT function can be selected as listed below:  
ONE (repeat only one track), ALL (repeat all tracks), RAN (repeat randomly), FOLD (repeat folders)

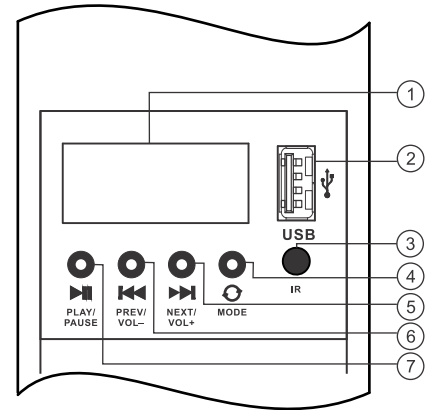

### RECORDING FUNCTION

- Insert a USB drive and press MODE button to select REC function. The LCD display will now appear like this:
- The REC function remains in || (PAUSE) mode till ▶|| (PLAY/PAUSE) button is pressed so as to start the recording. The LCD display will appear like this:

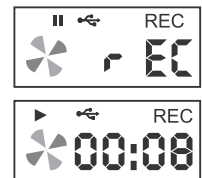

## • Output LEDs & Master Controls & Functions

- LEFT CHANNEL LED ARRAY:** The green SIGNAL LED glows when nominal signal level is available in LEFT MASTER output. The red CLIP LED glows when excessive (saturated) signal level is present in LEFT MASTER output.
- RIGHT CHANNEL LED ARRAY:** The green SIGNAL LED glows when nominal signal level is available in RIGHT MASTER output. The red CLIP LED glows when excessive (saturated) signal level is present in RIGHT MASTER output.
- LEFT & RIGHT CHANNEL POWER LED:** These red POWER LEDs will glow when the power switch is put ON and supply voltage is available for both L & R channels.
- MASTER 'LEFT' VOLUME CONTROL:** For adjusting the level of output signal as available through LEFT output jack.
- MASTER 'RIGHT' VOLUME CONTROL:** For adjusting the level of output signal as available through RIGHT output jack.

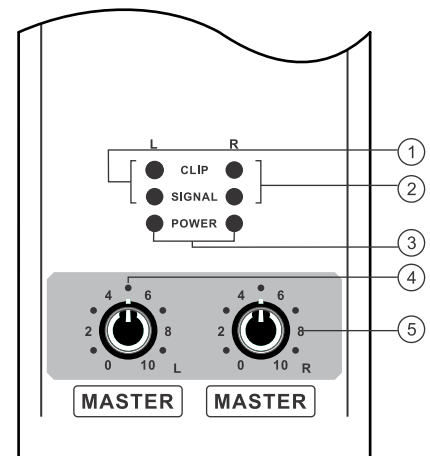



## • Remote Control

- Power:** Press once to switch OFF MP3 player, press again to switch ON the MP3 player.
- ▶||PLAY/PAUSE:** Press Play/Pause once to Pause when music is already playing. Press Play/Pause again to resume playing.
- EQ:** For selecting the equalizer setting from six preset EQ options.
- RPT:** For selecting various repeat options one by one.
- Number key 0 to 9. To choose the track number to be played.
- MODE :** To select , USB, REC or Bluetooth option.
- MUTE:** Press once to mute the sound, press again to resume the sound.
- ◀◀:** Press to select the previous track.
- ▶▶:** Press to select the next track.
- Vol-:** Press to decrease the volume of MP3 Player.
- Vol+:** Press to increase the volume of MP3 Player.
- U/SD:** NOT FUNCTIONAL
- Battery Replacement:** Pull out the battery tray and replace the battery with positive electrode facing upwards as shown in fig. below. Push the battery compartment back to the close position. Use CR2025 or equivalent lithium coin cell.

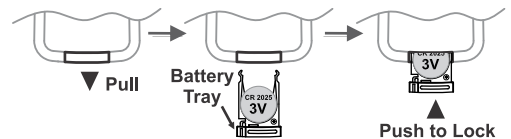
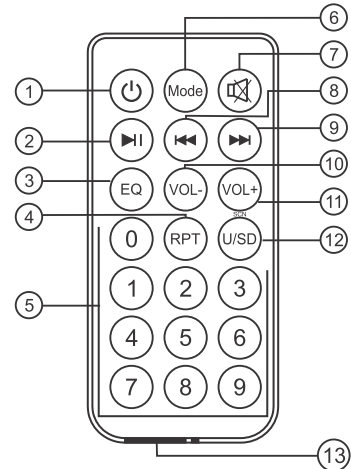

## • Pairing of Bluetooth Device

SWITCH ON the mixer in use. The default condition of the MP3 digital Player is USB mode. The display shows NO.

To play the MP3 programme from mobile phone or laptop via bluetooth, the PAIRING of the bluetooth devices of mobile phone & mixer is necessary. To use Bluetooth, press Mode switch to select BLUE (Bluetooth).

### Pairing is done as follows:

SELECT the Bluetooth option in Mobile Phone or laptop & follow the instructions appearing on mobile/laptop screen.

### Normally the following general instructions are followed:

Press ACTIVATE /ON/DISCOVERABLE/SEARCH, etc, as applicable in the mobile phone or laptop used.

The mobile phone or laptop starts searching for the new Bluetooth device. The moment FMX appears on the mobile phone or laptop, select the new device i.e. FMX and press OK or allow it to appear on mobile. System is ready to use.

Select the MP3 programme from mobile phone or laptop and press PLAY. The same song starts playing on the Ahuja mixer. We can SELECT Volume, Fast Forward, Rewind, Play/Pause function either from keys or through Remote Control.

**Note:** It is not necessary that all functions of remote control will be activated through Bluetooth and compatibility varies from mobile to mobile.

## • Plugs Wiring

### MIC (Ch. 1 & Ch. 2)

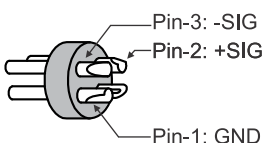

### MIC, LINE, OUTPUT (Bal.) & PHONES

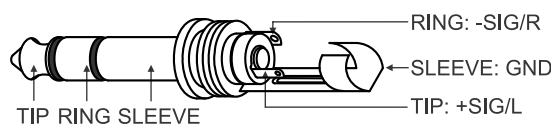

### MIC, LINE, OUTPUT (Unbalanced)

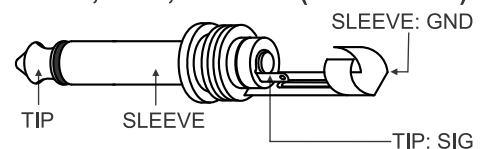

## • Interconnections

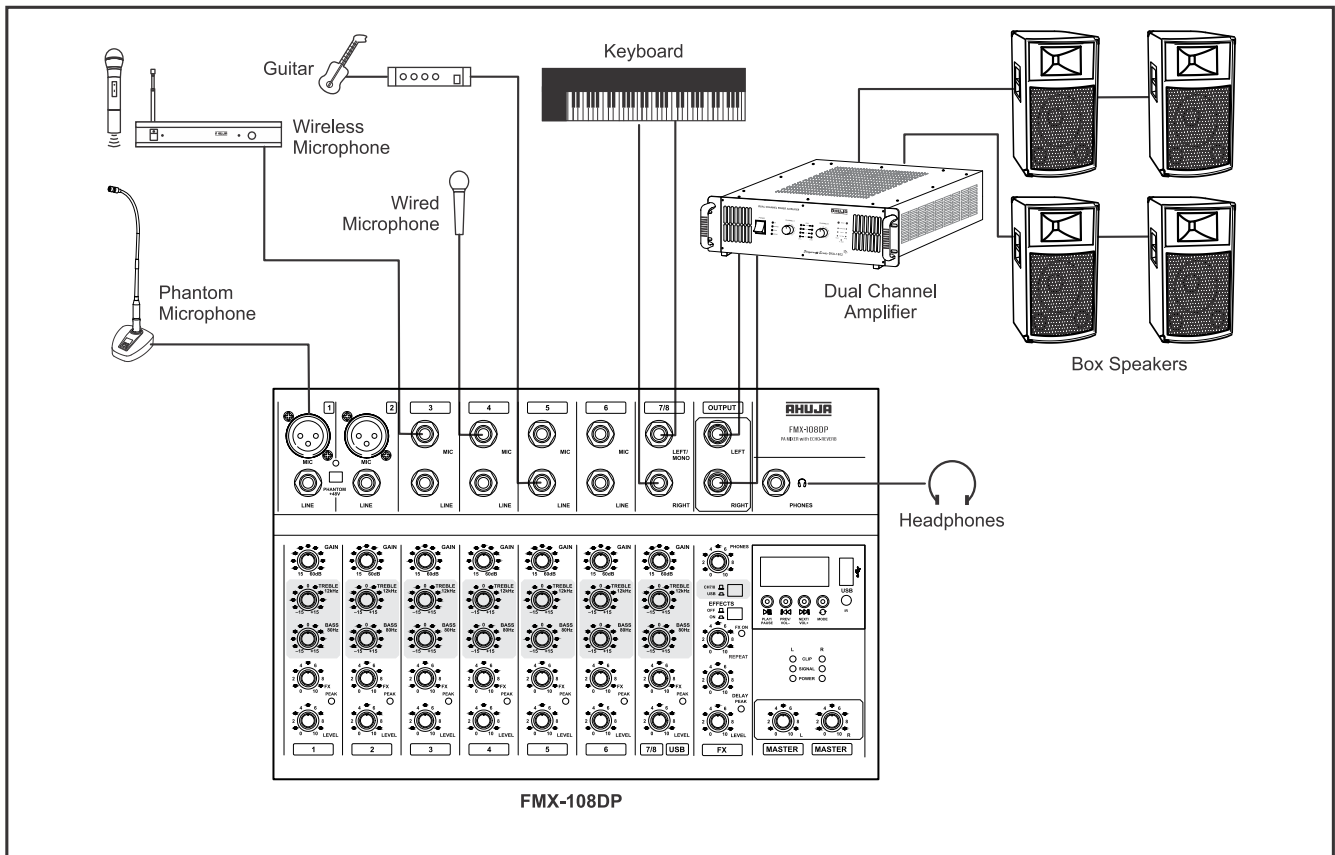

## • Specifications

<p><b>MIC INPUT</b> (Impedance/Gain) : 2k<math>\Omega</math> Balanced/65dB 1k<math>\Omega</math> Unbalanced/65dB</p> <p><b>LINE INPUT</b> (Impedance/Gain) : 20k<math>\Omega</math> Balanced/45dB 10k<math>\Omega</math> Unbalanced/45dB</p> <p><b>THD</b> : &lt; 0.1 %</p> <p><b>FREQUENCY RESPONSE</b> : 25Hz-20 kHz (-1dB)</p> <p><b>EQUALISATION</b> Bass/Treble : <math>\pm 15</math>dB at 80 Hz / <math>\pm 15</math>dB at 12kHz</p> <p><b>DIGITAL RECORDER</b> : MP3 Recorder &amp; Playback</p> <p><b>DELAY RANGE</b> : Variable from 20 to 300ms</p>	<p><b>LINE OUTPUT L/R</b> Nominal : 0dBu (775mv) Maximum : +21dBu (9V)</p> <p><b>OUTPUT IMPEDANCE</b> : 600<math>\Omega</math></p> <p><b>HEADPHONE OUTPUT</b> : 200mV at 8<math>\Omega</math></p> <p><b>S/N RATIO</b> : &gt; 68dB</p> <p><b>CLIP LED INDICATION</b> : 4dB prior to true clip</p> <p><b>POWER SUPPLY</b> : 220-240V AC 50Hz</p> <p><b>PROTECTION</b> : AC: Fuse 1Amp. 250V (T 1A L)</p> <p><b>DIMENSIONS</b> : W345 x H75 x D210mm</p> <p><b>WEIGHT</b> : 1.85kg approx.</p>
---	---

Design and Specifications are subject to change without notice owing to continuous product up-gradation. Technical specifications are subject to production tolerances.

We cannot be held responsible for printing errors, should they occur. **AHUJA** is a registered trademark of Ahuja Radios in India and other countries.

© Copyright Ahuja Radios, 2022. All rights reserved. Any unauthorized reproduction or use of logos, images or design elements is strictly prohibited by law.

No part of this compilation may be reproduced in any manner or translated without written permission.

### AHUJA RADIOS

215, Okhla Industrial Estate, New Delhi-110020, INDIA

C-45, Phase-II, Noida-201305 (UP) INDIA • 3, Okhla Industrial Estate, New Delhi-110020 INDIA

Tel.: +91-11-26831549, 41612474 Fax: +91-11-26847287 E-mail: ahuja@ahujaradios.com

Website: www.ahujaradios.com